

M18FOPH-LTA GRASS TRIMMER ATTACHMENT XXX

4932464955 - M18FOPH-LTA - 4000491606

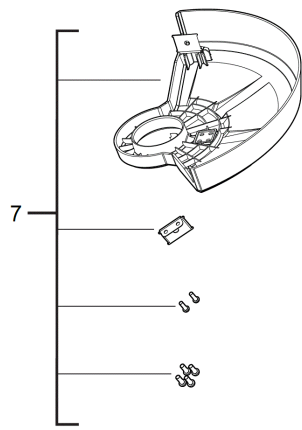



Since Autum 2024

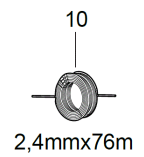
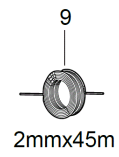
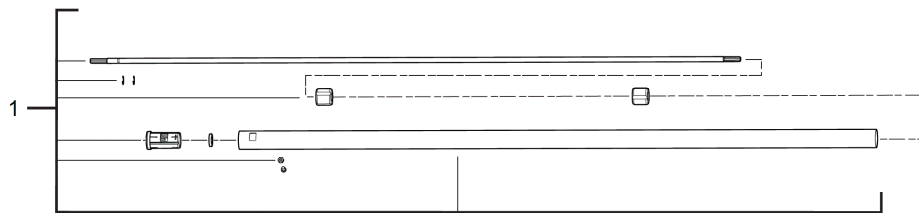
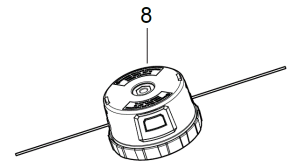
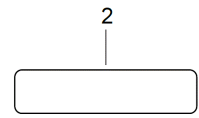
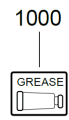
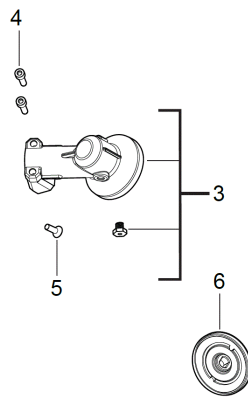
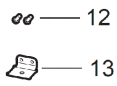
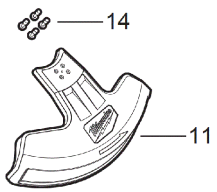

Position	Quantity	Description	Part number	EAN
0001 1	1	DRIVING SHAFT	4931466777	4058546279943
0002 2	1	RATING PLATE	4931495488	4058546491567
0003 3	1	GEAR CASE	4931466779	4058546279967
0004 4	2	SCREW	4931465533	4058546236335
0005 5	1	SCREW	4931466780	4058546279974
0006 6	1	INTERLOCK PLATE	4931466781	4058546279981
0007 7	1	COVER	4931454810	4058546014278
0008 8	1	Easy Load Trimmer Head Gen II 1pc	4932480180	4058546404659
0009 9	1	Trimmer Line 2mm x 45m - 1PC	49162712	45242493906
0010 10	1	Trimmer Line 2.4m x 76m - 1PC	49162713	45242493913
0011 11	1	GUARD	4931494975	4058546486433
0012 12	2	SCREW	4931473877	4058546364458
0013 13	1	BLADE	4931494974	4058546486426
0014 14	4	BOLT	4931494976	4058546486440
1000 15	1	GEAR GREASE	4931443288	4002395255627