

# M18BOS125-502B BTY. ORBITAL SANDER IN2

4933464229 - M18BOS125B-502 - 4000467519

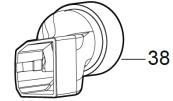

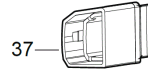
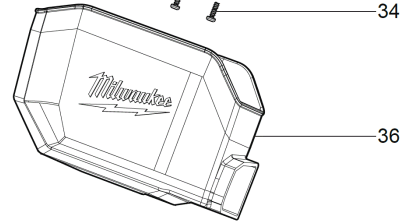
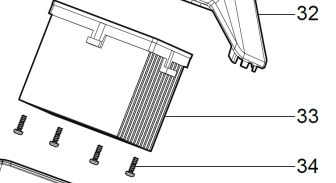
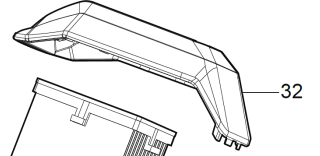
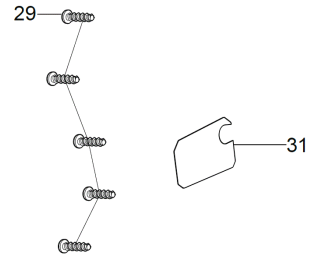
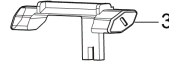
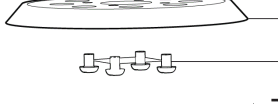
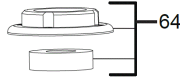
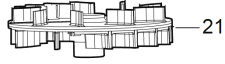
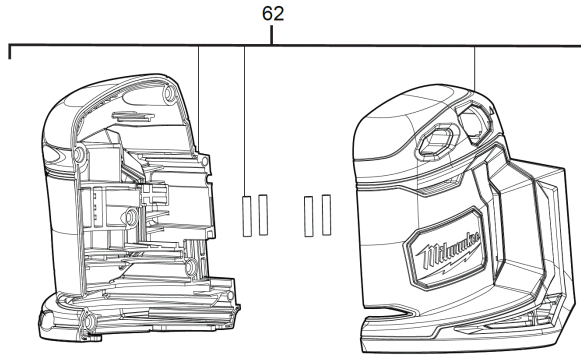
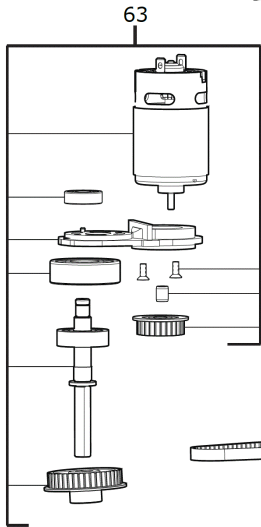
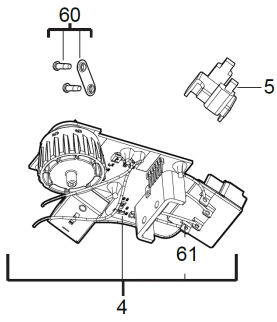

Position	Quantity	Description	Part number	EAN
0003 1	1	SWITCH LEVER	4931465600	4058546237004
0004 2	1	ELECTRONIC	4931465601	4058546237011
0005 3	1	HOLDER	4931465602	4058546237028
0006 4	1	PRESSURE SPRING	4931408243	4002395814466
0019 5	1	STRAP	4931465603	4058546237035
0021 6	1	BALANCE WEIGHT	4931465604	4058546237042
0024 7	1	SCREW	4931465605	4058546237059
0029 8	5	SCREW	4931465606	4058546237066
0031 9	1	RATING PLATE	4931465607	4058546237073
0032 10	1	PROTECTIVE CAP	4931465608	4058546237080
0033 11	1	PAPER FILTER	4931465609	4058546237097
0034 12	4	SCREW	4931465610	4058546237103
0036 13	1	TANK	4931465611	4058546237110
0037 14	1	EXTENSION	4931465612	4058546237127
0038 15	1	ADAPTOR	4931465613	4058546237134
0060 16	1	HOLDING PLATE	4931465614	4058546237141
0061 17	1	TERMINAL STRIP	302119005	4002395856152
0062 18	1	HOUSING	4931465615	4058546237158
0063 19	1	MOTOR ASSEMBLY	4931465616	4058546237165
0064 20	1	BALL BEARING	4931465617	4058546237172