

M18FDD3-502X DRILL DRIVER GEN 4 IN2

4933479863 - M18FDD3-502X - 4000481305

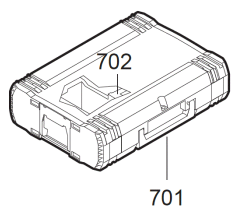

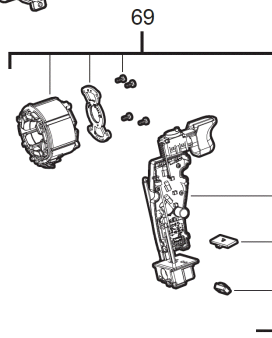
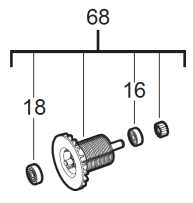
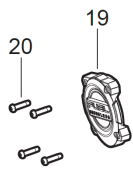
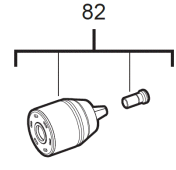
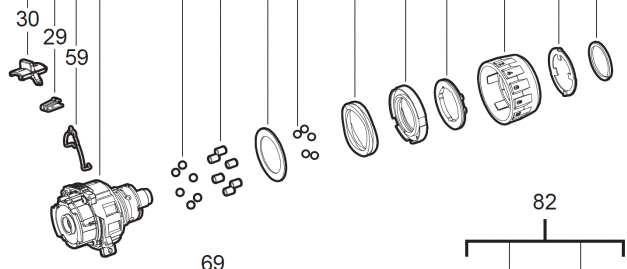
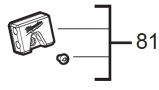
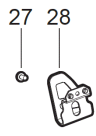
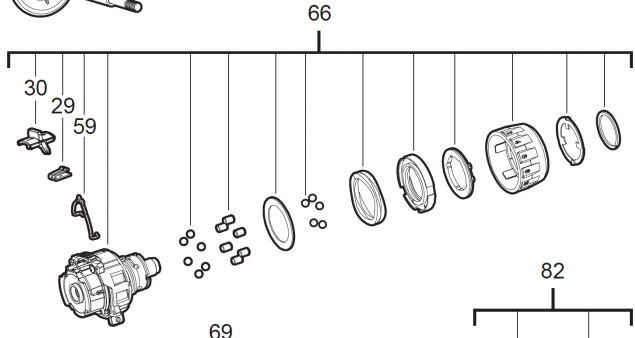
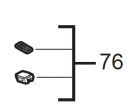
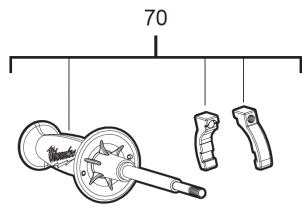
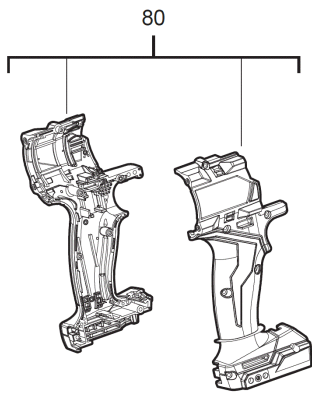

Position	Quantity	Description	Part number	EAN
0012 1	4	SCREW	4931465984	4058546272012
0016 2	1	BALL BEARING	4931479944	4058546397074
0018 3	1	BALL BEARING	4931465987	4058546272043
0019 4	1	PROTECTIVE CAP	4931494902	4058546474744
0020 5	9	SCREW	4931465499	4058546235994
0024 6	1	SWITCH LEVER	4931494903	4058546474751
0025 7	2	SCREW	4931454852	4058546020262
0027 8	1	SCREW	4931465986	4058546272036
0028 9	1	HOOK	4931436134	4002395879427
0029 10	1	SPRING	4931494904	4058546474768
0030 11	1	SWITCH BUTTON	4931494905	4058546474775
0059 12	1	SPRING	4931494906	4058546474782
0062 13	1	RATING PLATE	4931494907	4058546474799
0066 14	1	GEAR BOX	4931494908	4058546474805
0068 15	1	ARMATURE	4931494909	4058546474812
0069 16	1	ELECTRONIC	4931507219	4058546597306
0070 17	1	HANDLE SET	4931494911	4058546474836
0076 18	1	LENS	4931494912	4058546474843
0080 19	1	HOUSING SET ASSY	4931494913	4058546474850
0081 20	1	HOLDER	4931494914	4058546474867
0082 21	1	CHUCK	4931494915	4058546474874
0702 22	1	INSERT	4931494916	4058546474881