

M18BDD-402X AKKU-BOHRSCHRAUBER IN2

4933446198 - M18BDD-402X - 4000481210

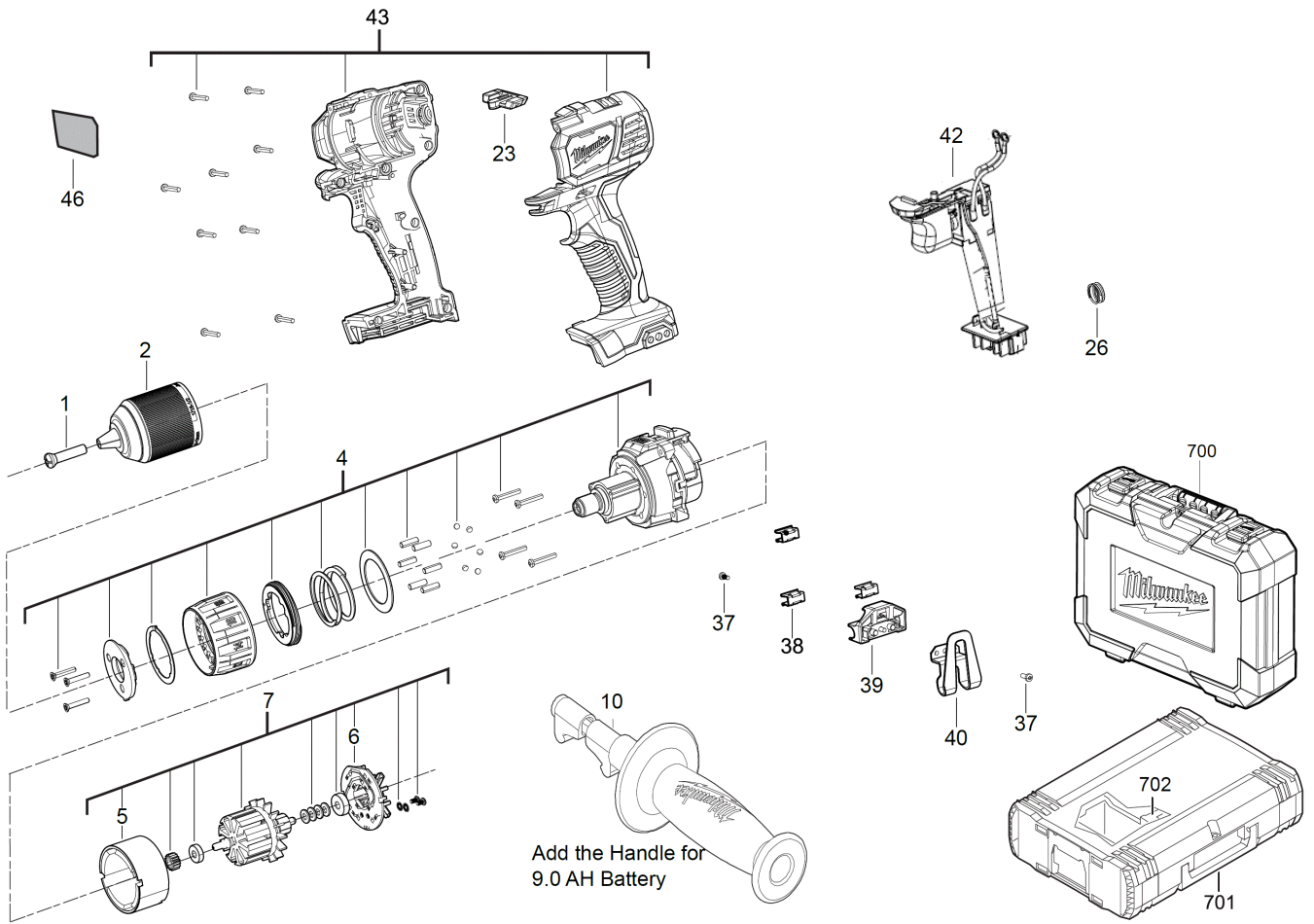



Position	Quantity	Description	Part number	EAN
0001 1	1	SCHRAUBE	4931433297	4002395896684
0002 2	1	BOHRFUTTER	4931472723	4058546330255
0004 3	1	GETRIEBEBAUSATZ	4931436130	4002395878789
0005 4	1	FELD F. ELEKTROMOTOR	4931431940	4002395898817
0006 5	1	KOHLEBUERSTE	4931436131	4002395878796
0007 6	1	MOTOR	4931436132	4002395879403
0010 7	1	ZUSATZHANDGRIFF	4931454527	4058546009557
0023 8	1	HEBEL	4931436133	4002395879410
0026 9	1	DRUCKFEDER	4931408243	4002395814466
0037 10	1	SCHRAUBE	660820001	4002395828920
0038 11	1	BITHALTER	630206001	4002395819164
0039 12	1	BITHALTER	516723001	4002395828975
0040 13	1	HAKEN	4931436134	4002395879427
0042 14	1	SCHALTELEKTRONIK	4931479931	4058546396947
0043 15	1	HANDGRIFF KOMPL.	4931479932	4058546396954
0046 16	1	LEISTUNGSSCHILD	4931479933	4058546396961
0700 17	1	TRANSPORTKOFFER	4931436138	4002395879465
0702 18	1	KOFFEREINSATZ	4931440936	4002395863129