

M18BLPD2-502X AKKU-SCHLAGBOHRER IN2

4933464517 - M18BLPD2-502X - 4000469172

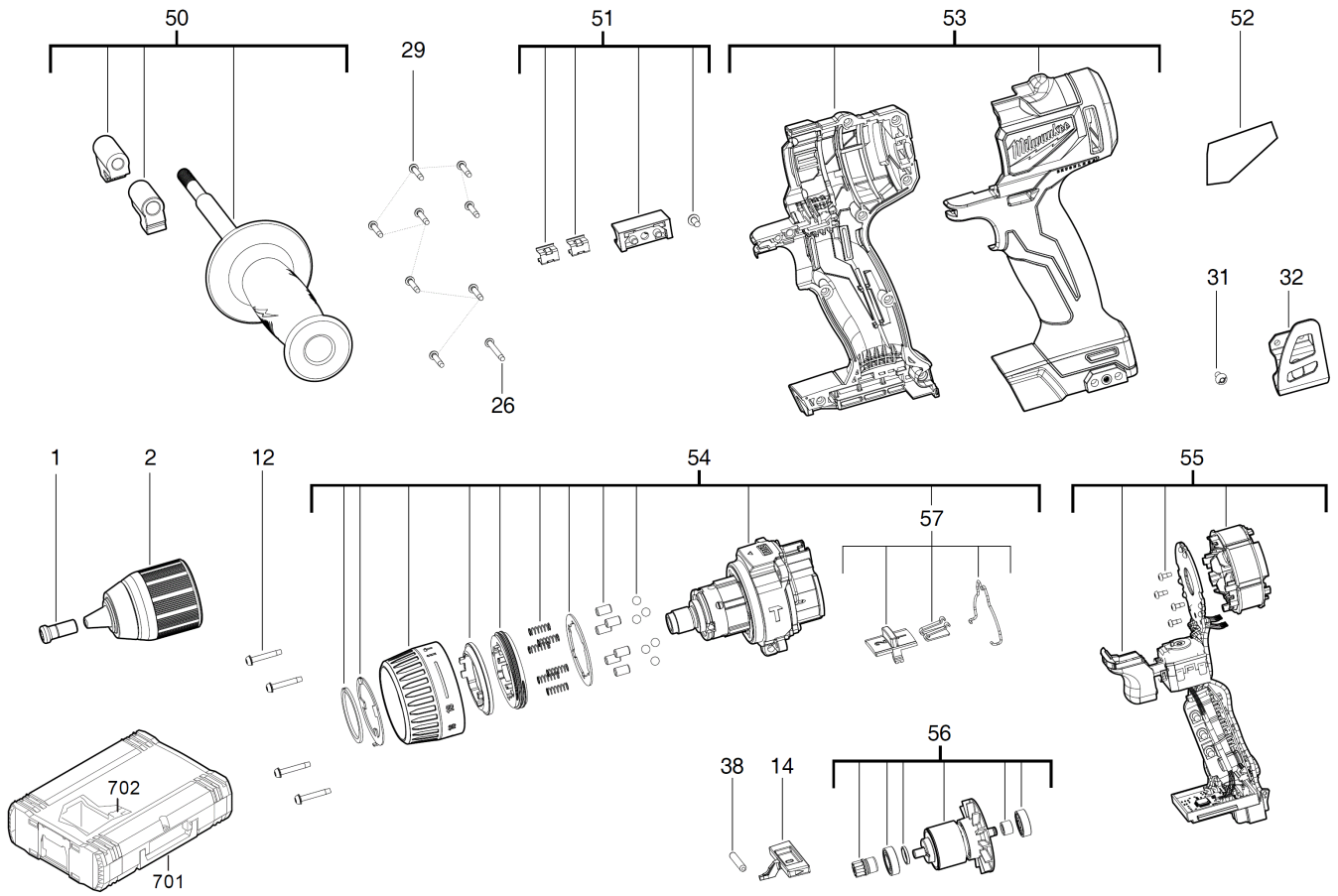



Position	Quantity	Description	Part number	EAN
0001 1	1	SICHERUNGSSCHRAUBE	4931453214	4002395151875
0002 2	1	BOHRFUTTER	4931466294	4058546275112
0012 3	4	SCHRAUBE	4931465984	4058546272012
0014 4	1	SCHIEBER	4931466285	4058546275020
0026 5	1	SCHRAUBE	4931465898	4058546239985
0029 6	8	SCHRAUBE	4931465499	4058546235994
0031 7	1	SCHRAUBE	4931465986	4058546272036
0032 8	1	HAKEN	4931436134	4002395879427
0038 9	1	STIFT	4931436155	4002395881604
0050 10	1	ZUSATZHANDGRIFF	4931466286	4058546275037
0051 11	1	BITHALTER	4931465832	4058546239329
0052 12	1	LEISTUNGSSCHILD	4931466295	4058546275129
0053 13	1	GEHAEUSE	4931466288	4058546275051
0054 14	1	GETRIEBEKASTEN	4931466296	4058546275136
0055 15	1	SCHALTER	4931466290	4058546275075
0056 16	1	MOTOREINHEIT	4931466291	4058546275082
0057 17	1	SCHALTER	4931466292	4058546275099
0702 18	1	EINSATZ	4931466293	4058546275105