

M12CLLP-0C Kreuzlinienlaser mit Lot

4933478101 - M12CLLP-0C - 4000477732

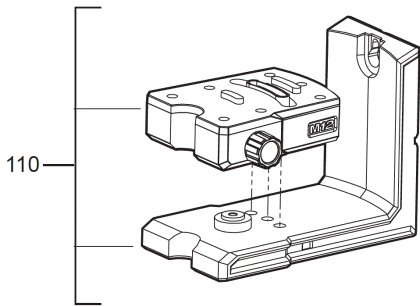

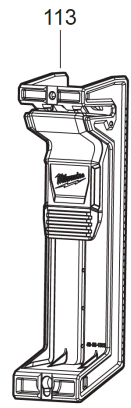
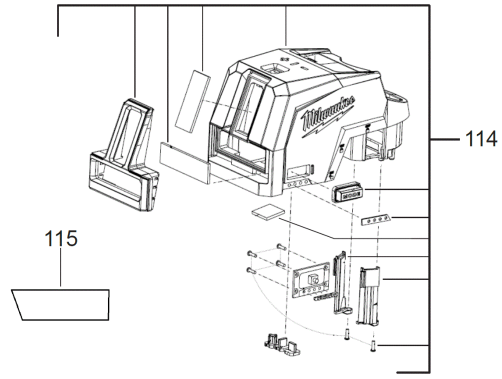
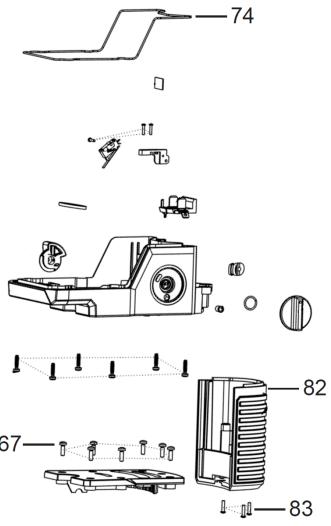

Position	Quantity	Description	Part number	EAN
0067 1	6	SCHRAUBE	4931508012	4058546626747
0074 2	1	DICHTUNG	4931508013	4058546626754
0082 3	1	DECKEL	4931508014	4058546626761
0083 4	3	SCHRAUBE	4931508015	4058546626778
0110 5	1	HALTERUNG	4931508993	4058546636555
0113 6	1	FEDERKLEMME	4931473858	4058546364267
0114 7	1	GEHAEUSE	4931508016	4058546626785
0115 8	1	LEISTUNGSSCHILD	4931508017	4058546626792
0700 9	1	TRANSPORTKASTEN	4931473863	4058546364311